

Oil-Free - Rocking Piston Pump

RP12



Max Flow	12 l/min
Max Vacuum	200 mbar abs
Max Pressure	6.0 bar

Oil free, low maintenance pumping

Utilising state of the art rocking piston technology, the RP12 oil free compressor provides a source of clean, compressed air at up to 6 bar without the need for oil mist filters or regular maintenance.

Adaptability and long life

Designed for continuous duty the RP12 incorporates a long life PTFE piston seal capable of more than 10,000 hrs running time under pressure loads of up to 6 bar. A wide variety of motor types and voltages are available including a brushless DC unit featuring on-board electronics, reduced size, up to 20,000 hrs life, low electrical noise and optional motor speed control.

Quiet, compact and lightweight

Designed for applications where size and weight need to be minimised, the RP12 features lightweight components, slim-line design and alternative head orientations to suit both portable and compact fixed installations.

Performance and reliability

Sustainable high performance is achieved by utilising robust materials, optimised surface finish on internal components and high temperature tolerant ball race bearings. The RP12 represents class leading performance with reliability designed in.

Application ideas

Application ideas include inkjet printing, instrument calibration, pneumatic valve operation, medical cuff inflation and humidification systems.

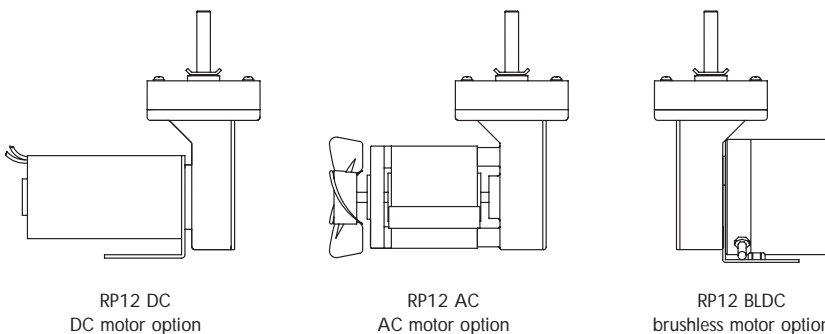

RP12 AC

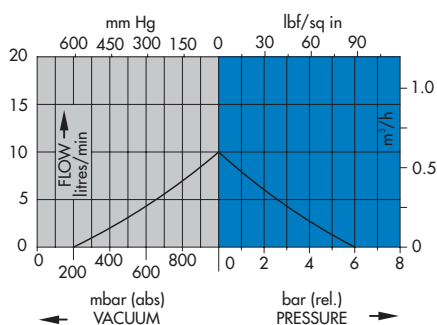

RP12 DC

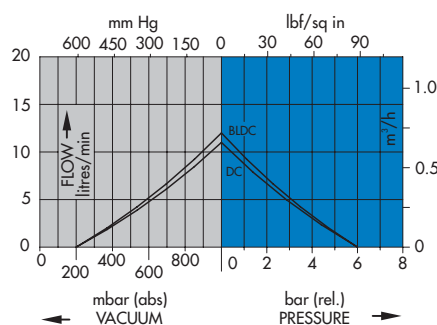

RP12

Technical Specifications

Motor Type

AC version: Skeleton frame, shaded pole with cooling fan and shielded ball races throughout. 2800 RPM. Thermal Protection 120°C.

DC version: Permanent Magnet 2800 RPM.

BLDC version: Brushless DC motor with integral electronics with speed control.

Voltage	RP12		
	Operating current	Max load	Fuse rating
230V 50Hz	0.5A	0.6A	1.0A
110V 50Hz/60Hz	1.1A	1.4A	2.0A
12V DC	2.0A	3.0A	4.0A
24V DC	1.0A	1.5A	2.0A
24V BLDC	0.7A	1.4A	2.0A

Technical Drawing

RP12 AC 1.75kg dimensions: mm

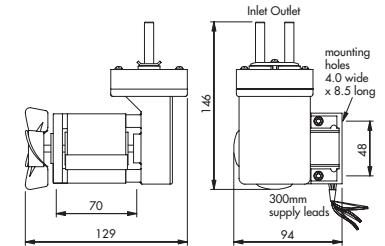

Performance

Model no.	Max free flow l/min	Max vacuum mbar (abs)	Max pressure bar
RP12 AC	10.0	200	6.0
RP12 DC	11.0	200	6.0
RP12 BLDC	12.0	200	6.0

RP12 DC 1.1kg

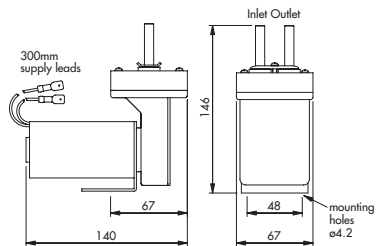

Pump Materials

Component	Standard
Head Cylinder	Hard anodised aluminium
Piston Seat	PTFE
Connectors	Stainless Steel
'O' Rings, Valves	Viton

RP12 BLDC 1.0kg

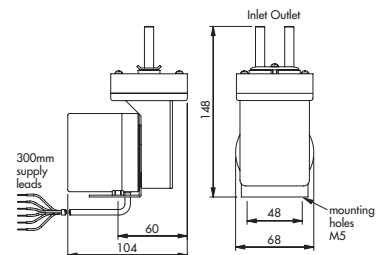

Distributed by:

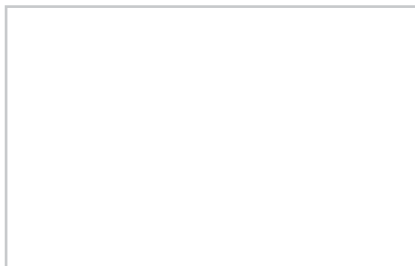

Connectors

Plain, vertical, stainless steel 8.0mm OD
Optional: plain, vertical, stainless steel 6.0, 6.4 mm OD

Please note - it is important that you ensure the motor specification stated and the range of materials offered in the pump are compatible with the performance, environmental limitations and chemical resistance requirements of the application.

For further information or details of our extensive range of pumps, contact our technical sales office who will be pleased to help you select the most suitable pump for your application

S30-232/2

